

STIR-MIX-HOMOGENIZE

S-MIX 40-950

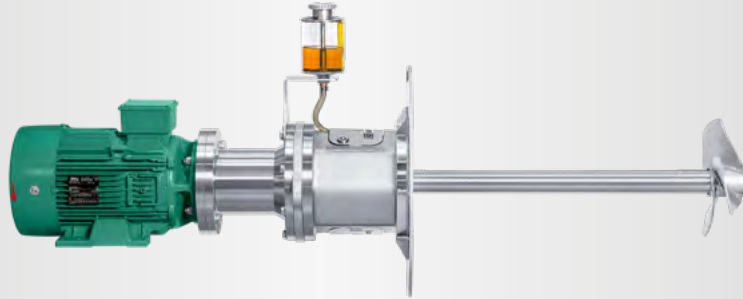

Application

Dry matter content up to 8 %
Substrate temperature up to 100°C
pH-values 5.5 - 8.2

Propeller

3-bladed, dynamically balanced propeller
S-MIX 40-950 | 4.0 kW | propeller LD 310 | 950 rpm
ss304, optional ss316

Technical data

Sealing plate Ø 550 mm,
other dimensions on request
Sealing by Cartridge cartridge mechanical seal
SiC/SiC
Shutoff device
(Enables seal replacement when the tank is full)



Bearing

2 spherical roller bearings , maintenance-free

Motor

Motor power: 4 kW (6-poles - 1,000 rpm*)
400 V, 50 Hz
PTC thermistors as overheat protection
Ex-Motor  II 3G Ex nA IIA T3 Gc (Ex-Zone 2)

Ex-Zone

Ex-zone 2 (outside the tank) and zone 1 (inside the tank)
Classification mechanical components
  II 2G Ex h IIA T3 Gb

* the actual rated speed of the motor may deviate slightly

Agitator shaft

Agitator shaft Ø 55 mm in ss304, optional in ss316
Length 0.6 / 0.8 m (other lengths on request)

Control box (optional)

Star-delta-switch, soft start or frequency converter
Delivery without connecting cable



بهنام‌دازین پارس

نمایندگی ایران

تلفن تماس : ۸ و ۸۸۳۲۴۹۳۷ - ۰۲۱

E-mail : sales@brp.co.ir

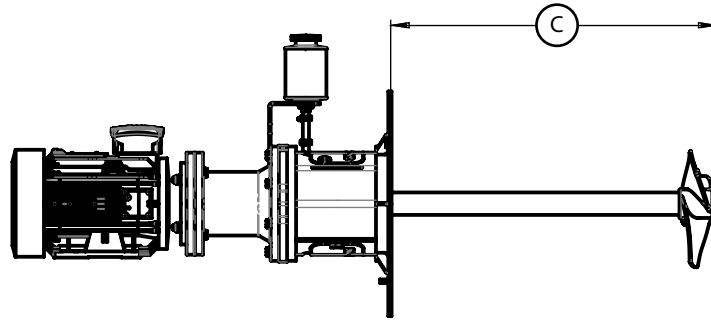
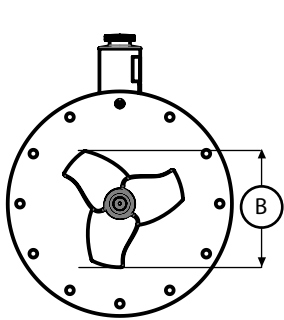

بینارزین پارس
نماینده‌گی ایران

تلفن تماس: ۸ و ۸۸۳۲۴۹۳۷ - ۰۲۱

E-mail: sales@brp.co.ir

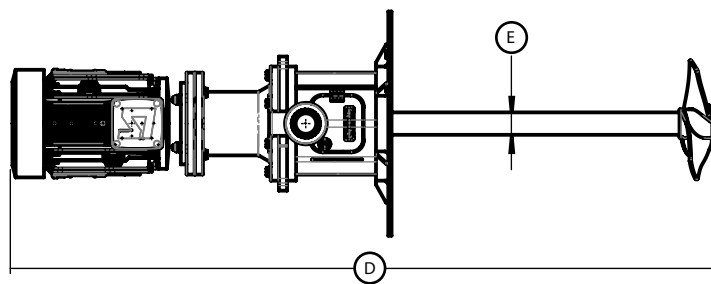

Dimensions

Type	A [mm]	B [mm]	C [mm]	D [mm]	E [∅ in mm]						
S-MIX 40-950	550	310	595	1.520	55						
			795	1.720							

Technical Data

Type	Rated power [kW]	Rated Voltage [V]	Rated Current [A]	Frequency [Hz]	Power factor cos φ	Propeller speed [rpm]	Propeller diameter [mm]	Axial force [kN]	Flow velocity [m/s] *	Pumping rate Water [m ³ /min]	Weight approximate [kg]
S-MIX 40-950	4.0	400	9.8	50	0.72	950	310	0.70	3.0	13	140

Subject to technical changes

* measured in water and 1.2 m distance

As per: 2023-05.1

© SUMA Rührtechnik GmbH | Martinszeller Str. 21 | DE-87477 Sulzberg

Phone: +49 8376 / 92131 - 0 | Fax: - 19 | info@suma.de | www.suma.de/en